

L06 Support Leg

12-13mm & 17-21mm

Includes fixings for both 12-13mm & 17-21mm			
Support Height	ANODISED	PPC	ADJUSTMENT
150mm Support Leg	L06150A	L06150P	+/- 8mm

M6X20mm All Thread (12-13mm)

M6X25mm All Thread (17-21mm)

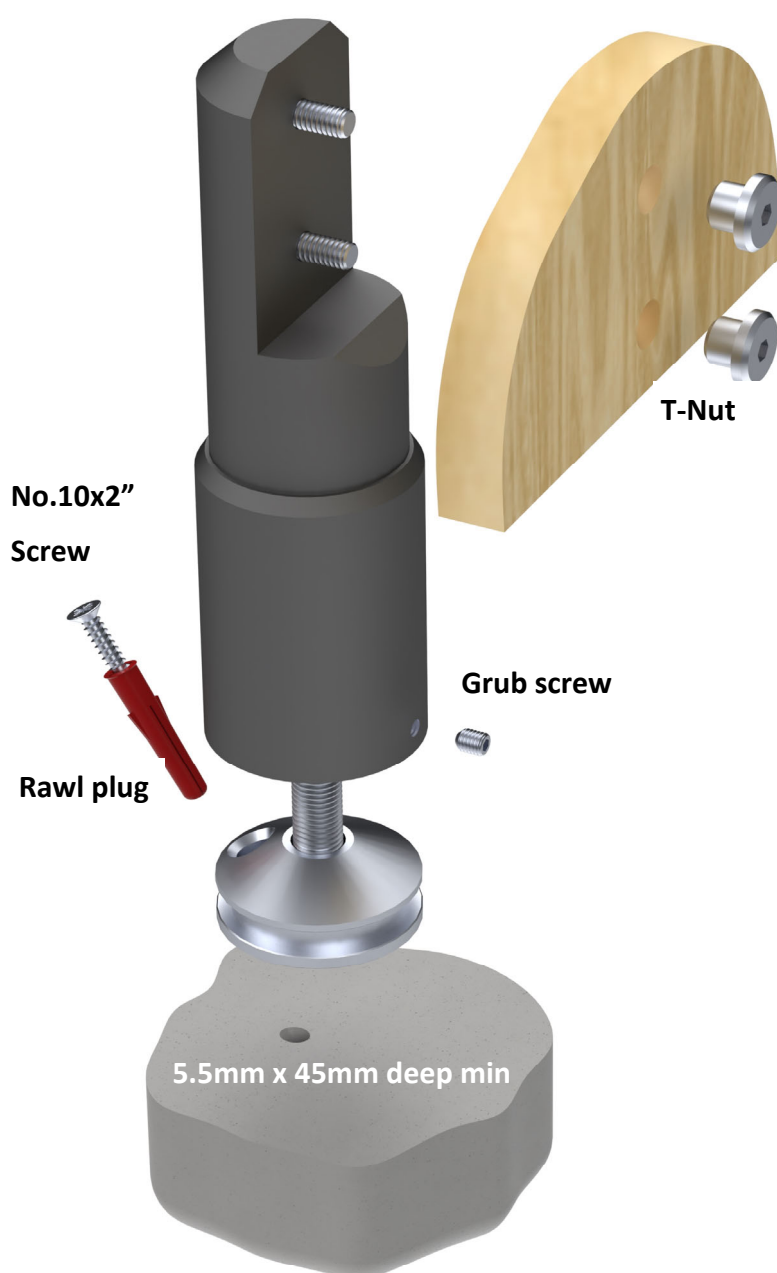

1. Mark off the vertical centreline of the leg onto the fascia and drill the two 10mm diameter holes and fit the leg as shown in the drawing.

2. Loosen the small retaining screw on the base of the leg and raise up the shroud to access the adjusting mechanism of the leg. Screw the foot up into the leg as far it will allow.

3. The partition can now be offered up to the wall mounting brackets and using packing pieces set the required height (normally 150mm).

4. The foot in the leg can now be adjusted down to the floor level until it takes the weight off the packing pieces. It can now be secured to the floor by drilling through the angle hole in the foot with a 5.5mm masonry drill, the holes need to be at least 45mm deep.

5. Push the red plug into the floor hole and secure the leg using the screw provided.

6. Lower the shroud in the leg until it is resting on the floor and secure using the small screw on the side of the leg.